

GELÄNDERPFOSTEN BALUSTRADE POSTS

Die neue Generation Brüstungen
the new generation of balustrades



Pauli + Sohn

Version 06
edition 06





Brüstungsverglasung mit Geländerpfosten

balustrade glazing with railing posts

Das Geländersystem ist eine Generation von Brüstungsverglasungen im Bauhausstil. Die sachliche Eleganz passt sich der Architektur in unaufdringlicher Weise an. Dieses Geländersystem ist ein statischer Problemlöser im Innen- und Außenbereich. Auch für öffentliche Gebäude besonders geeignet.

The balustrade system is a generation in the sense of Bauhaus style. The factual elegance adds to the architecture in an unobtrusive way. This balustrade system is a static problem solver in both indoor and outdoor use. Also suitable for public buildings.





- Sicherheit durch abP bis Anpralllasten von 1,0 kN
 - vergüteter Flachstahl feuerverzinkt und pulverbeschichtet
 - sehr filigrane Gesamtoptik (Querschnitt 12 x 60 mm)
 - großzügige Pfostenabstände ermöglichen Glasbreiten bis 3800 mm
 - Endlosmontage ohne weitere Aussteifung in den Ecken möglich
 - günstiger Glasaufbau (12,76 mm)
 - Kantenschutz vor Nässe und Stoß mit durchgehendem U-Profil aus Edelstahl
 - zweiseitig linienförmig gelagerte Verglasung nach DIN 18008
 - schnelle Glasmontage durch obere Klemmfixierung der Scheibe
 - sicher geführte Glasmontage durch feste Nut am Fuß des Pfostens
 - schmale Glasfugen von 10 mm bieten eine höhere Winddichtigkeit
 - für Aufsatz- und Vorsatzmontage geeignet
- safety with abP and beam loads up to 1.0 kN
 - galvanized and powder-coated flat steel
 - filigree appearance (cross section 12 x 60 mm)
 - large post spacing allows glass widths up to 3800 mm
 - finite assembly without further bracing in the corners possible
 - favorable glass thickness (12,76 mm)
 - edge protection against moisture and impact with continuous U-profile made of stainless steel
 - two-sided linear glazing according to DIN 18008
 - quick glass installation due to upper clamping fixation of the panel
 - secure glass mounting due to fixed slot at the base of the post
 - narrow glass butts of 10 mm provide higher wind reduction
 - suitable for floor and front mounting

abP = german national technical certification

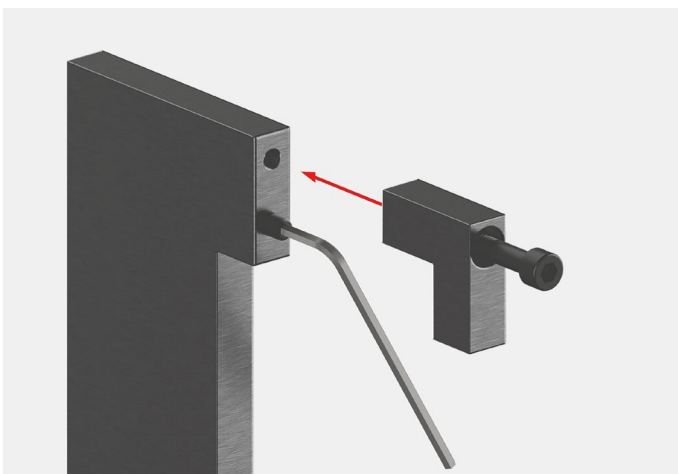

Die obere Klemmfixierung wird angeschraubt. Die Klemmung des U-Profiles kann durch die im Pfosten eingebaute Madenschraube variiert werden.

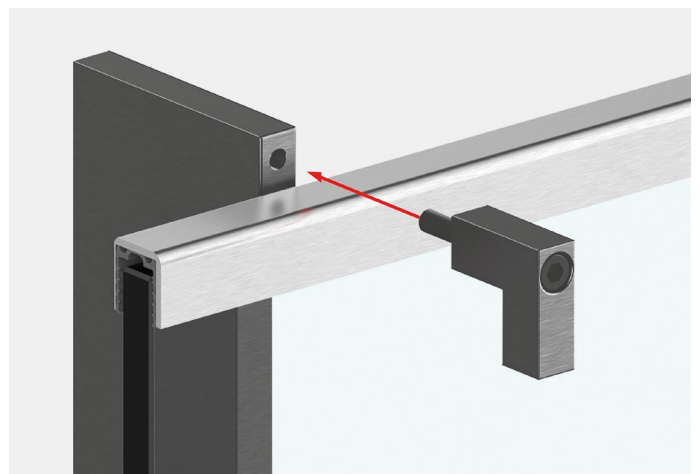

The upper clamp is attached with screws. The clamping of the u-profile can be varied by the grub screw installed in the post.

Prüfzeugnisse erhalten neue Nummern, wenn sie verlängert, d. h. erneuert werden. Wenden Sie sich in solchen Fällen an uns, um Informationen zu erhalten.
Test certificates become new numbers when renewed. In these cases contact us for information.

Scheibenaufbau = VSG aus 6mm ESG / ESG-HF, 0,76mm PVB

glass composition = LSG of 6mm FTG / FTG-HF, 0,76mm PVB



Abmessung Geländersystem mit 2 Pfosten

dimensions for balustrade system with 2 posts

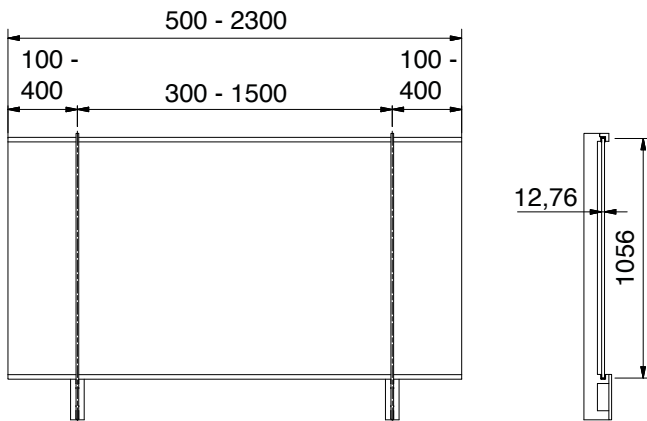

Abmessung Geländersystem mit 3 Pfosten

dimensions for balustrade system with 3 posts

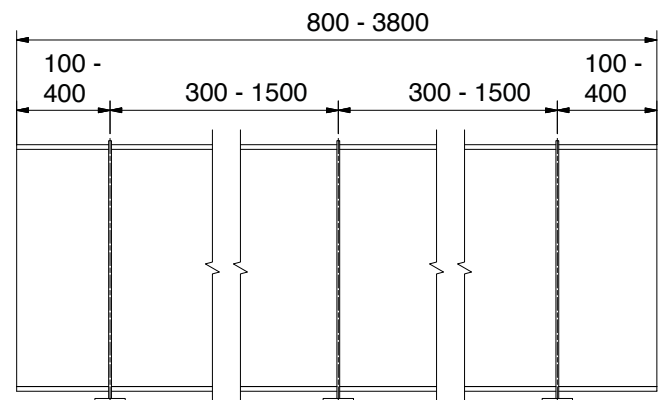
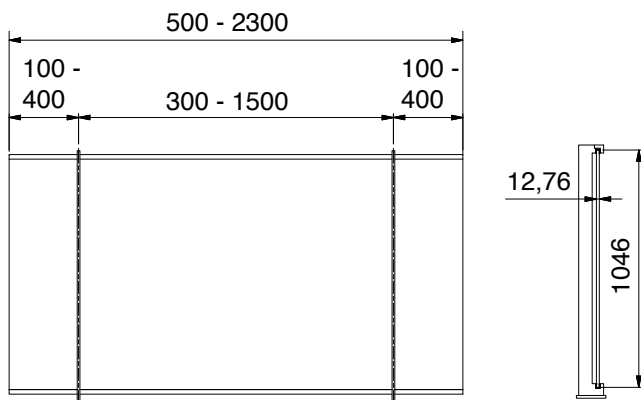
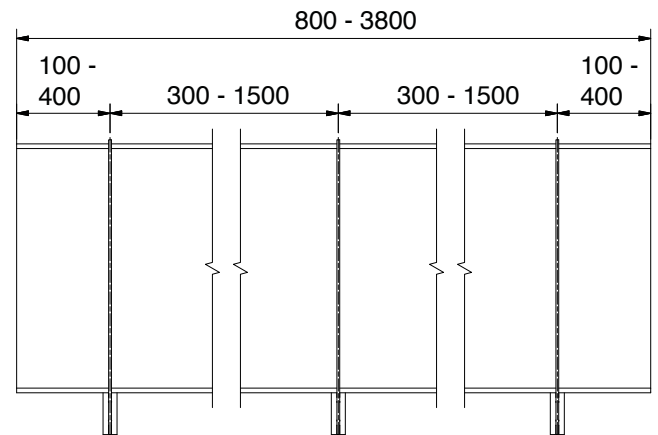

Prüfzeugnisse erhalten neue Nummern, wenn sie verlängert, d. h. erneuert werden. Wenden Sie sich in solchen Fällen an uns, um Informationen zu erhalten.
 Test certificates become new numbers when renewed. In these cases contact us for information.



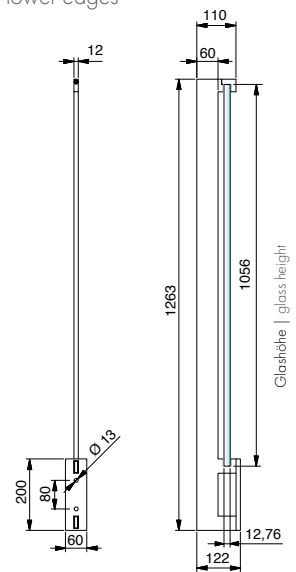

Geländerpfosten – mit U-Profil oben / U-Profil unten

balustrade posts with U-profiles on the upper and lower edges



Einzelpfosten für Frontmontage | single post for fascia mounting

Oberfläche: RAL 7016 pulverbeschichtet mit Feinstruktur
surface: RAL 7016 powder coated with fine structure

Art.-Nr. art.-no.	Material material	Sicherheit safety	
10244912R7016FS	Stahl verzinkt steel, zinc galvanised		12,76 VSG aus ESG LSG of FTG

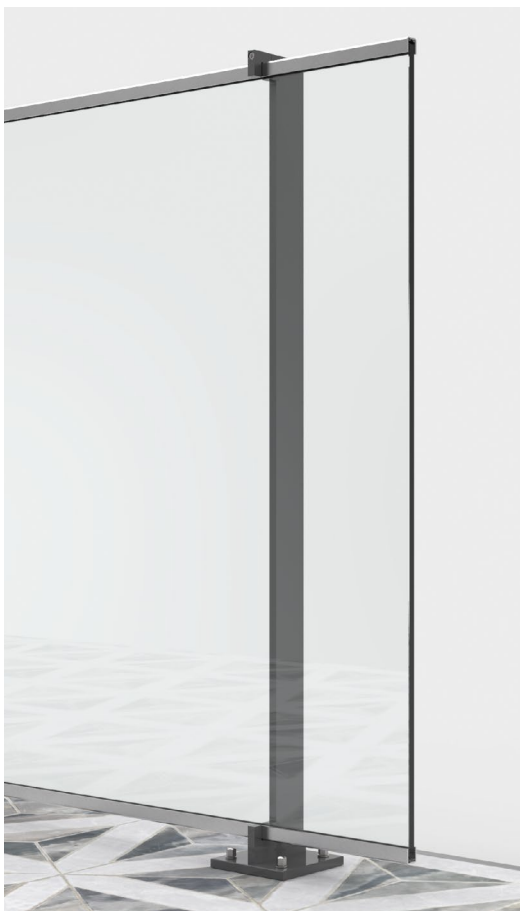

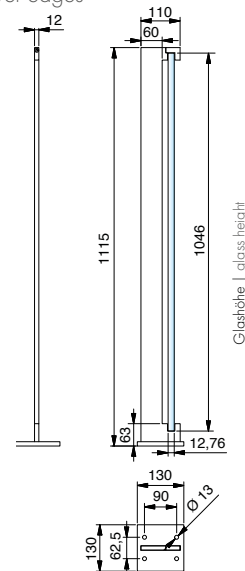
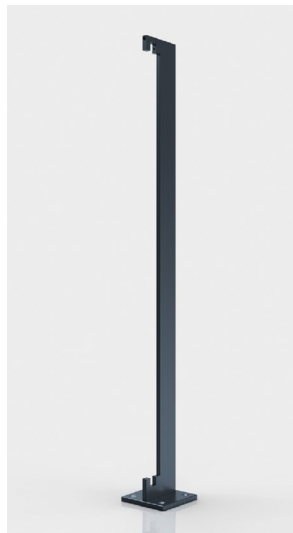

Geländerpfosten - mit U-Profil oben / U-Profil unten

balustrade posts with U-profiles on the upper and lower edges



Einzelpfosten für Aufsatzmontage | single post for floor mounting

Oberfläche: RAL 7016 pulverbeschichtet mit Feinstruktur
surface: RAL 7016 powder coated with fine structure

Art.-Nr. Art.-no.	Material material	Sicherheit safety	
10244812R7016FS	Stahl verzinkt steel, zinc galvanised		12,76 VSG aus ESG LSG of FTG

Scheibenaufbau für Treppen = VSG aus 6mm ESG / ESG-HF, 0,76mm PVB

glass composition for stairs = LSG of 6mm FTG / FTG-HF, 0,76mm PVB

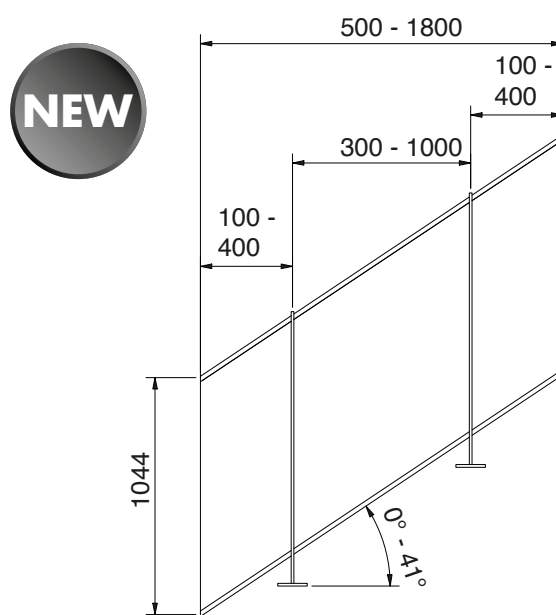
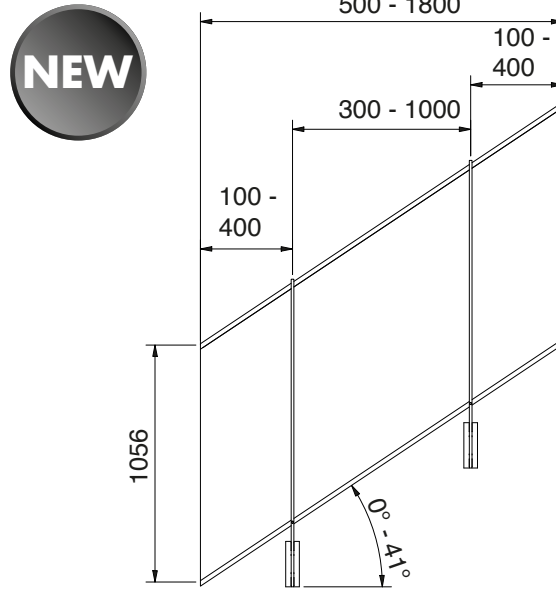

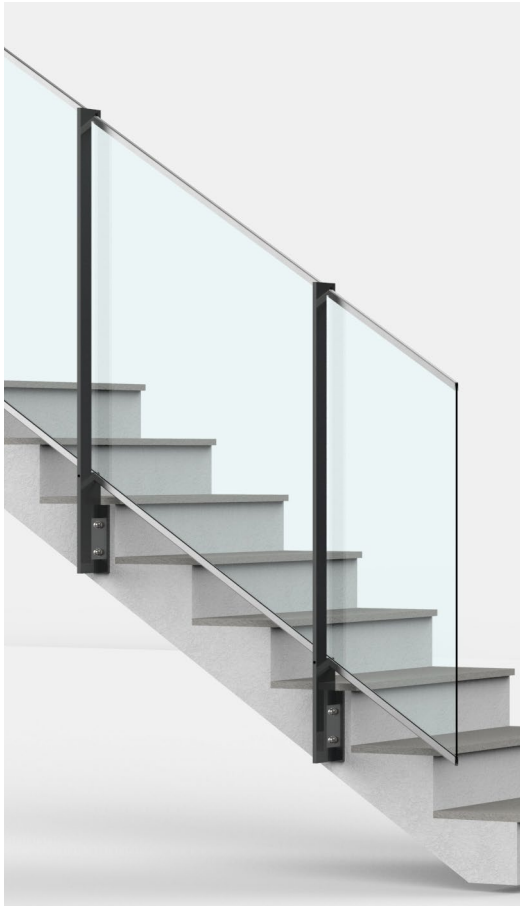

Geländerpfosten für Treppenanschluss – mit U-Profil oben / U-Profil unten

balustrade posts with U-profiles on the upper and lower edges

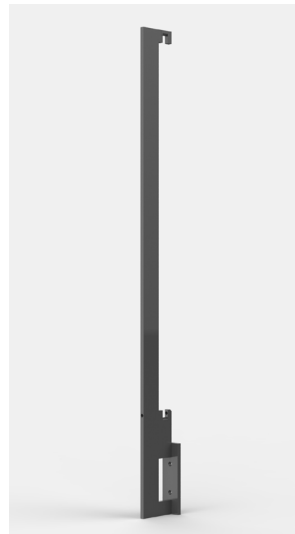

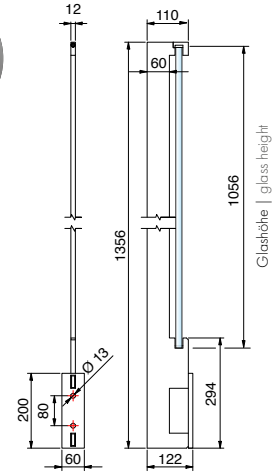

NEW



Treppen-Einzelpfosten für Frontmontage | single post for fascia mounting

Oberfläche: RAL 7016 pulverbeschichtet mit Feinstruktur
surface: RAL 7016 powder coated with fine structure

Art.-Nr. art.-no.	Material material	Sicherheit safety		
10247812R7016FS	Stahl verzinkt steel, zinc galvanised		12,76	VSG aus ESG LSG of FTG

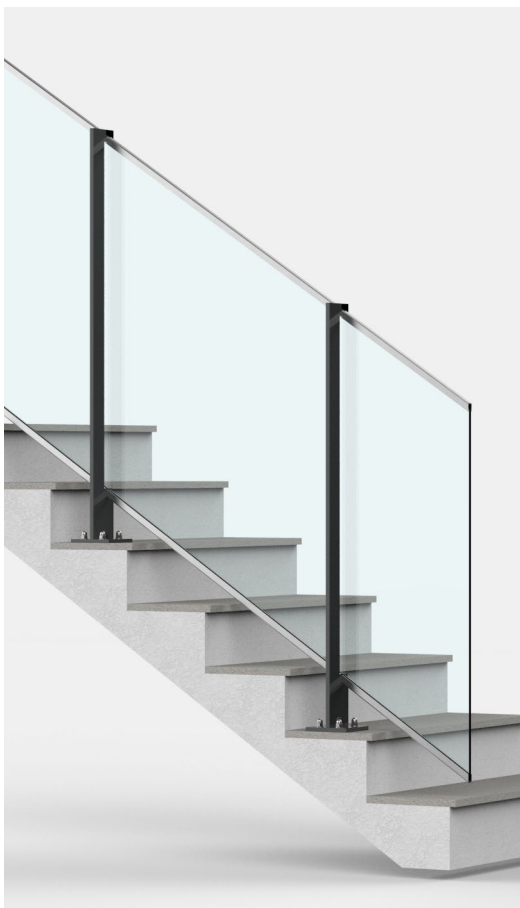

Geländerpfosten für Treppenanschluss - mit U-Profil oben / U-Profil unten

balustrade posts with U-profiles on the upper and lower edges

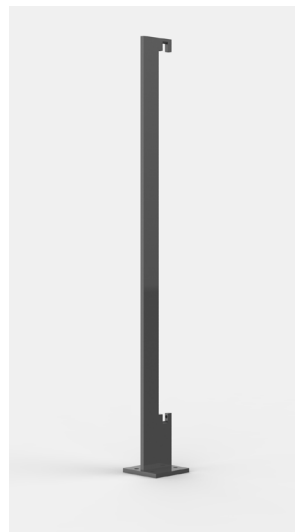

NEW

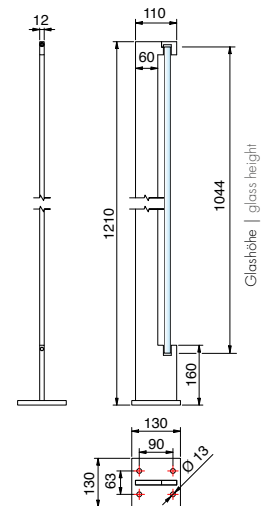

Treppen-Einzelpfosten für Aufsatzmontage | single post for floor mounting

Oberfläche: RAL 7016 pulverbeschichtet mit Feinstruktur
surface: RAL 7016 powder coated with fine structure

Art.-Nr. Art.-no.	Material material	Sicherheit safety		
10247712R7016FS	Stahl verzinkt steel, zinc galvanised		12,76	VSG aus ESG LSG of FTG



U-Profil und Gummiprofil | U-profile and elastomer profile



5020VA2-5M/-2500

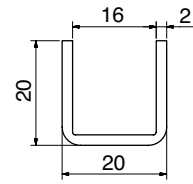



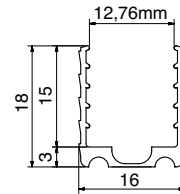

10245320KU-5M



U-Profil | U-profile

Oberfläche: geschliffen
surface: brushed

Art.-Nr. art.-no.	Material material		Länge length	Oberfläche surface	
5020VA2-2500	A2 304		12,76	2500	Korn grain 320
5020VA2-5M	A2 304		12,76	5000	Korn grain 320
10245320KU-5M	Elastomer		12,76	5000	-

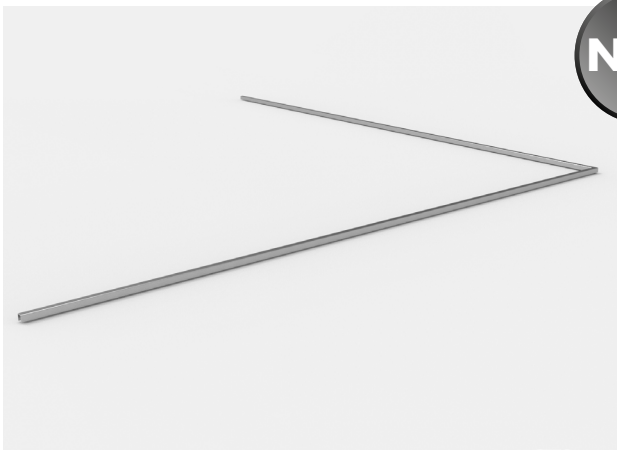

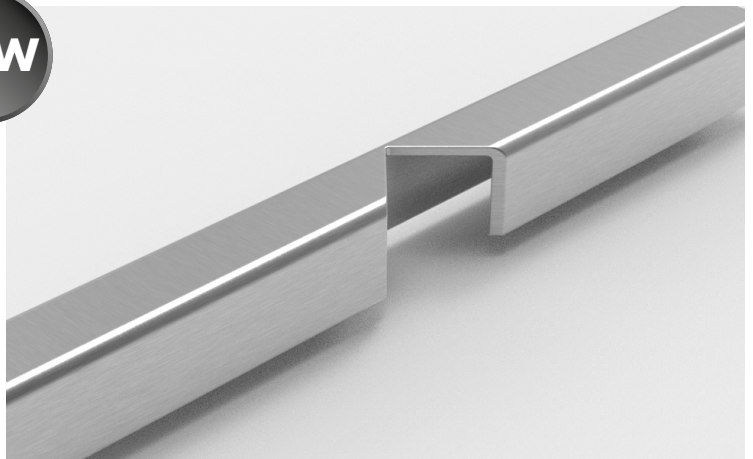

NEW



U-Profil, ausgeklinkt | U-profile, notched

Oberfläche: geschliffen
surface: brushed

Art.-Nr. art.-no.	Material material		Länge length	Oberfläche surface	
5020VA2-2500-90B	A2 304		12,76	2500	Korn grain 320
5020VA2-5000-90B	A2 304		12,76	5000	Korn grain 320

U-Profil für 90° Eckverbindungen

Das Profil ist ab Werk in der Mitte ausgeklinkt - damit kann ein 90° Gehrungswinkel ohne Schweißen auf der Baustelle hergestellt werden - beide Schenkel-Enden werden nach der Montage am Glas mit den Klammern von mindestens 2 benachbarten Geländerpfosten jeweils links/rechts fixiert.

U-profile for 90° corner joints

The profile is notched in the middle - this means that a 90° mitre angle can be produced on site without welding - both ends of the leg are fixed to the glass with the clamps of at least 2 adjacent uprights on the left/right after installation.



Art.-Nr. P-02-06-10

Version 06

Alle Bilder, technische Zeichnungen und deren Beschreibungen sind urheberrechtlich geschütztes Eigentum der Pauli + Sohn GmbH. Technische Maßangaben innerhalb des Kataloges sind unverbindlich. Konstruktionsänderungen sind vorbehalten. Bitte beachten Sie unsere Schutzrechte. Für Druckfehler und Irrtümer, die bei der Herstellung unterlaufen sind, ist jede Haftung ausgeschlossen.

www.pauli.de

Technischer Stand: Mai 2025

art.-no. P-02-06-10

Edition 06

All images, technical drawings and descriptions are copyrighted property of the Pauli + Sohn GmbH. Technical measurements within the catalog are not binding and are subject to change. Any liability for printing errors which have occurred during the preparing of this brochure is excluded.

www.pauli.de

technical status: May 2025



Pauli + Sohn GmbH

Werk I:

Eisenstraße 2

D-51545 Waldbröl

Telefon: +49 (0) 22 91-92 06-0

Fax: +49 (0) 22 91-92 06-681

Werk II:

Industriestraße 20

D-51597 Morsbach

Telefon: +49 (0) 22 94-98 03-0

Fax: +49 (0) 22 94-98 03-881

www.pauli.de

info@pauli.de